



Battery testing guide

- Why backup batteries are needed
- Battery types
- Failure modes
- Maintenance philosophies
- Practical battery testing
- Frequently asked questions
- Megger products overview

Megger

WWW.MEGGER.COM

Contents

Why backup batteries are needed.....	4	Float current	16
Why test battery systems	4	Ripple current	16
Why batteries fail.....	4	Temperature.....	16
Battery types.....	5	Data analysis.....	17
Lead-acid overview	5	Locating ground faults on DC systems without sectionalizing.....	18
Nickel-Cadmium Overview.....	5	Overview	18
Battery construction and nomenclature.....	6	Current test methods.....	18
Configurations.....	6	A better test method	18
Single post batteries.....	6	Frequently asked questions	19
Multiple post batteries	6	Battery technology summary.....	19
Failure modes	7	Megger products overview.....	20
Lead-acid (flooded) failure modes	7	Impedance test equipment.....	20
Lead-acid (VRLA) failure modes	7	BITE® 3	20
Nickel-Cadmium failure modes	8	BITE® 2 and BITE®2P.....	21
Maintenance philosophies	9	ProActiv battery database management software.....	21
How to maintain the battery.....	9	BITE® accessories.....	21
Standards and common practices.....	9	Capacity testing	23
IEEE 450.....	9	TORCEL 820/840/860	23
Inspections	9	TORCEL accessories.....	23
Capacity test (discharge test) should be done.....	9	Ground fault tracing equipment.....	24
IEEE 1188.....	10	Battery Ground Fault Tracer (BGFT).....	24
Inspections	10	Battery Ground-fault Locator (BGL)	24
Capacity test (capacity test) should be done.....	10	Digital Low Resistance Ohmmeters (DLRO) and Microhmmeters (MOM)	26
Battery replacement criteria	10	DLRO® 247000 series.....	26
IEEE 1106.....	10	DLRO10 and DLRO10X	26
Inspections	10	MJÖLNER 200 and MJÖLNER 600	27
Capacity test (discharge test) should be done.....	10	MOM200A and MOM600A.....	27
Summary best way to test and evaluate your battery.....	10	MOM690	27
Test intervals	10	Multimeters	28
Evaluation.....	10	MMC850 Multi-conductor AC Digital Clampmeter	28
Practical battery testing	11	Multimeters	28
Capacity test.....	11	Insulation Resistance Test Equipment.....	29
Battery testing matrix – IEEE recommended practices.....	11	MIT400 series insulation resistance testers.....	29
Procedure for capacity test of vented lead acid battery.....	12		
Impedance test	13		
Impedance theory.....	13		
Intercell connection resistance.....	14		
Testing and electrical paths.....	15		
Voltage	15		
Specific gravity	15		

Why backup batteries are needed

Batteries are used to ensure that critical electrical equipment is always on. There are so many places where batteries are used – it is nearly impossible to list them all. Some of the applications for batteries include:

- Electric generating stations and substations for protection and control of switches and relays
- Telephone systems to support phone service, especially emergency services
- Industrial applications for protection and control
- Back up of computers, especially financial data and information
- “Less critical” business information systems

Without battery back-up hospitals would have to close their doors until power is restored. But even so, there are patients on life support systems that require absolute 100% electric power. For those patients, as it was once said, “failure is not an option.”

Just look around to see how much electricity we use and then to see how important batteries have become in our everyday lives. The many blackouts of 2003 around the world show how critical electrical systems have become to sustain our basic needs. Batteries are used extensively and without them many of the services that we take for granted would fail and cause innumerable problems.

Why test battery systems

There are three main reasons to test battery systems:

- To insure the supported equipment is adequately backed-up
- To prevent unexpected failures by tracking the battery's health
- To forewarn/predict death

And, there are three basic questions that battery users ask:

- What are the capacity and the condition of the battery now?
- When will it need to be replaced?
- What can be done to improve / not reduce its life?

Batteries are complex chemical mechanisms. They have numerous components from grids, active material, posts, jar and cover, etc. – any one of which can fail. As with all manufacturing processes, no matter how well they are made, there is still some amount of black art to batteries (and all chemical processes).

A battery is two dissimilar metallic materials in an electrolyte. In fact, you can put a penny and a nickel in half of a grapefruit and you now have a battery. Obviously, an industrial battery is more sophisticated than a grapefruit battery. Nonetheless, a battery, to work the way it is supposed to work must be maintained properly. A good battery maintenance program may prevent, or at least, reduce the costs and damage to critical equipment due to an AC mains outage.

Even though there are many applications for batteries, they are installed for only two reasons:

- To protect and support critical equipment during an AC outage
- To protect revenue streams due to the loss of service

The following discussion about failure modes focuses on the mechanisms and types of failure and how it is possible to find weak cells. Below is a section containing a more detailed discussion about testing methods and their pros and cons.

Why batteries fail

In order for us to understand why batteries fail, unfortunately a little bit of chemistry is needed. There are two main battery chemistries used today – lead-acid and nickel-cadmium. Other chemistries are coming, like lithium, which is prevalent in portable battery systems, but not stationary, yet.

Volta invented the primary (non-rechargeable) battery in 1800. Planté invented the lead-acid battery in 1859 and in 1881 Faure first pasted lead-acid plates. With refinements over the decades, it has become a critically important back-up power source. The refinements include improved alloys, grid designs, jar and cover materials and improved jar-to-cover and post seals. Arguably, the most revolutionary development was the valve-regulated development. Many similar improvements in nickel-cadmium chemistry have been developed over the years.

Battery types

There are several main types of battery technologies with subtypes:

- Lead-acid
 - ▶ Flooded (wet): lead-calcium, lead-antimony
 - ▶ Valve Regulated Lead-acid, VRLA (sealed): lead-calcium, lead-antimony-selenium
 - ▶ Absorbed Glass Matte (AGM)
 - ▶ Gel
 - ▶ Flat plate
 - ▶ Tubular plate
- Nickel-cadmium
 - ▶ Flooded
 - ▶ Sealed
 - ▶ Pocket plate
 - ▶ Flat plate

Lead-acid overview

The basic lead-acid chemical reaction in a sulphuric acid electrolyte, where the sulphate of the acid is part of the reaction, is:

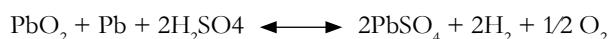

The acid is depleted upon discharge and regenerated upon recharge. Hydrogen and oxygen form during discharge and float charging (because float charging is counteracting self-discharge). In flooded batteries, they escape and water must be periodically added. In valve-regulated, lead-acid (sealed) batteries, the hydrogen and oxygen gases recombine to form water. Additionally, in VRLA batteries, the acid is immobilized by an absorbed glass matte (AGM) or in a gel. The matte is much like the fibre-glass insulation used in houses. It traps the hydrogen and oxygen formed during discharge and allows them to migrate so that they react back to form water. This is why VRLA never need water added compared to flooded (wet, vented) lead-acid batteries.

A battery has alternating positive and negative plates separated by micro-porous rubber in flooded lead-acid, absorbed glass matte in VRLA, gelled acid in VRLA gel batteries or plastic sheeting in NiCd. All of the like-polarity plates are welded together and to the appropriate post. In the case of VRLA cells, some compression of the plate-matte-plate sandwich is exerted to maintain good contact between them. There is also a self-resealing, pressure relief valve (PRV) to vent gases when over-pressurization occurs.

Nickel-Cadmium Overview

Nickel-Cadmium chemistry is similar in some respects to lead-acid in that there are two dissimilar metals in an electrolyte. The basic reaction in a potassium hydroxide (alkaline) electrolyte is:

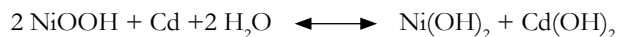

However, in NiCd batteries the potassium hydroxide (KOH) does not enter the reaction like sulphuric acid does in lead-acid batteries. The construction is similar to lead-acid in that there are alternating positive and negative plates submerged in an electrolyte. Rarely seen, but available, are sealed NiCd batteries.

Battery construction and nomenclature

Now that we know everything there is to know about battery chemistry, except for Tafel curves, ion diffusion, Randles equivalent cells, etc., let's move on to battery construction. A battery must have several components to work properly: a jar to hold everything and a cover, electrolyte (sulphuric acid or potassium hydroxide solution), negative and positive plates, top connections welding all like-polarity plates together and then posts that are also connected to the top connections of the like-polarity plates.

All batteries have one more negative plate than positive plate. That is because the positive plate is the working plate and if there isn't a negative plate on the outside of the last positive plate, the whole outer side of last positive plate will not have anything with which to react and create electricity. Hence, there is always an odd number of plates in a battery, e.g., a 100A33 battery is comprised of 33 plates with 16 positive plates and 17 negative plates. In this example, each positive plate is rated at 100 Ah. Multiply 16 by 100 and the capacity at the 8-hour rate is found, namely, 1600 Ah. Europe uses a little different calculation than the US standards.

In batteries that have higher capacities, there are frequently four or six posts. This is to avoid overheating of the current-carrying components of the battery during high current draws or lengthy discharges. A lead-acid battery is a series of plates connected to top lead connected to posts. If the top lead, posts and intercell connectors are not sufficiently large enough to safely carry the electrons, then overheating may oc-

cur (i^2R heating) and damage the battery or in the worst cases, damage installed electronics due to smoke or fire.

To prevent plates from touching each other and shorting the battery, there is a separator between each of the plates. Figure 1 is a diagram of a four-post battery from the top looking through the cover. It does not show the separators.

Configurations

Batteries come in various configurations themselves. Add to that the many ways that they can be arranged, the number of possible configurations is endless. Of course, voltage plays the biggest part in a battery configuration. Batteries have multiple posts for higher current draws. The more current needed from a battery, the bigger the connections must be. That includes posts, intercell connectors and buss bars and cables.

Single post batteries

Smaller battery systems are usually the simplest battery systems and are the easiest to maintain. They usually have single post batteries connected with solid intercell connectors. Frequently, they are quite accessible but because they are small and can be installed in a cubby hole occasionally, they may be quite inaccessible for testing and maintenance.

Multiple post batteries

Batteries with multiple posts per polarity start to become interesting quickly. They are usually larger and frequently are more critical.

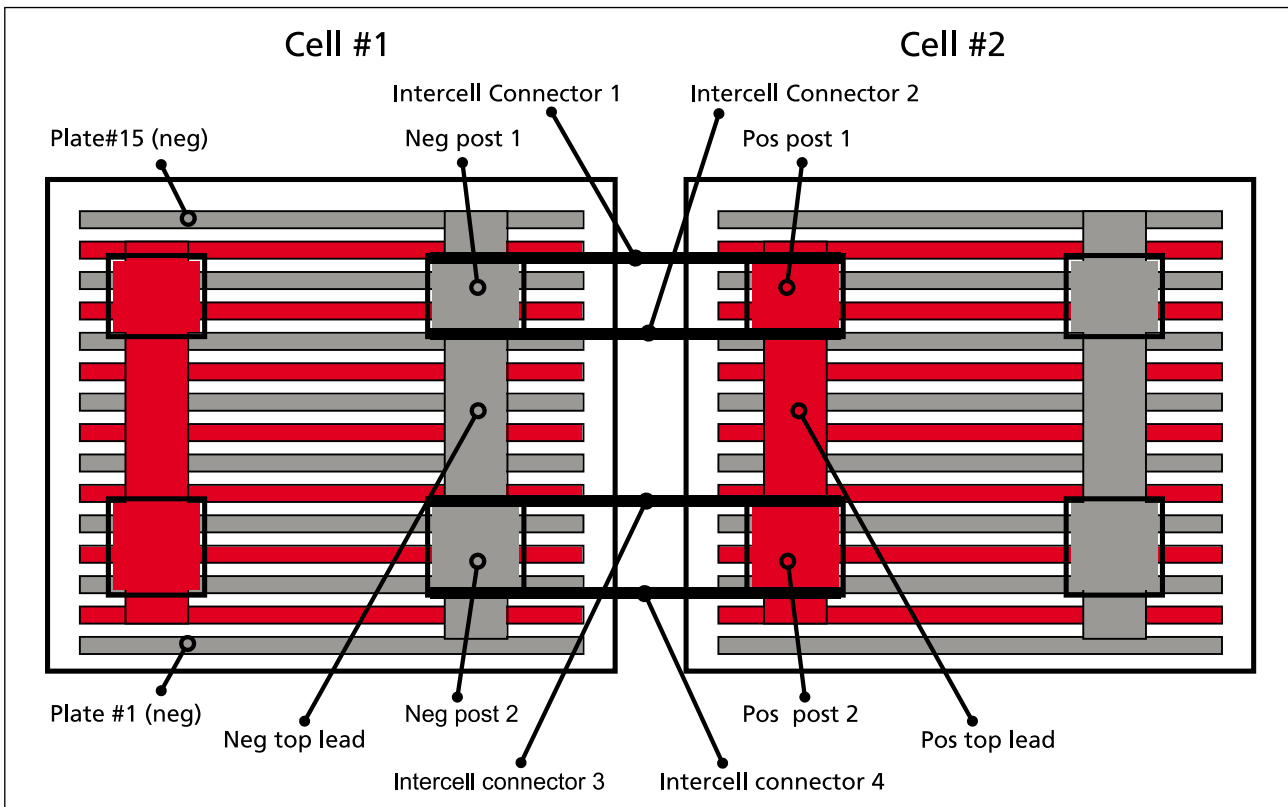

Figure 1 Battery construction diagram

Failure modes

Lead-acid (flooded) failure modes

- Positive grid corrosion
- Sediment (shedding) build-up
- Top lead corrosion
- Plate sulphation
- Hard shorts (paste lumps)

Each battery type has many failure modes, some of which are more prevalent than others. In flooded lead-acid batteries, the predominant failure modes are listed above. Some of them manifest themselves with use such as sediment build-up due to excessive cycling. Others occur naturally such as positive grid growth (oxidation). It is just a matter of time before the battery fails. Maintenance and environmental conditions can increase or decrease the risks of premature battery failure.

Positive grid corrosion is the expected failure mode of flooded lead-acid batteries. The grids are lead alloys (lead-calcium, lead-antimony, lead-antimony-selenium) that convert to lead oxide over time. Since the lead oxide is a bigger crystal than lead metal alloy, the plate grows. The growth rate has been well characterized and is taken into account when designing batteries. In many battery data sheets, there is a specification for clearance at the bottom of the jar to allow for plate growth in accordance with its rated lifetime, for example, 20 years.

At the designed end-of-life, the plates will have grown sufficiently to pop the tops off of the batteries. But excessive cycling, temperature and over-charging can also increase the speed of positive grid corrosion. Impedance will increase over time corresponding to the increase in electrical resistance of the grids to carry the current. Impedance will also increase as capacity decreases as depicted in the graph in figure 2.

Sediment build-up (shedding) is a function of the amount of cycling a battery endures. This is more often seen in UPS batteries but can be seen elsewhere. Shedding is the sloughing off of active material from the plates, converting to white lead sulphate. Sediment build-up is the second reason battery manufacturers have space at the bottom of the jars to allow for a certain amount of sediment before it builds-up to the point of shorting across the bottom of the plates rendering the battery useless. The float voltage will drop and the amount of the voltage drop depends upon how hard the short is. Shedding, in reasonable amounts, is normal.

Some battery designs have wrapped plates such that the sediment is held against the plate and is not allowed to drop to the bottom. Therefore, sediment does not build-up in wrapped plate designs. The most common application of wrapped plates is UPS batteries.

Corrosion of the top lead, which is the connection between the plates and the posts is hard to detect even with a visual inspection since it occurs near the top of the battery and is hidden by the cover. The battery will surely fail due to the high current draw when the AC mains drop off. The heat build-up when discharging will most likely melt the crack open and then the entire string drops off-line, resulting in a catastrophic failure.

Plate sulphation is an electrical path problem. A thorough visual inspection can sometimes find traces of plate sulphation. Sulphation is the process of converting active plate material to inactive white lead sulphate. Sulphation is due to low charger voltage settings or incomplete recharge after an outage. Sulphates form when the voltage is not set high enough. Sulphation will lead to higher impedance and a lower capacity.

Lead-acid (VRLA) failure modes

- Dry-out (Loss-of-Compression)
- Plate Sulphation (see above)
- Soft and Hard Shorts
- Post leakage
- Thermal run-away
- Positive grid corrosion (see above)

Dry-out is a phenomenon that occurs due to excessive heat (lack of proper ventilation), over charging, which can cause elevated internal temperatures, high ambient (room) temperatures, etc. At elevated internal temperatures, the sealed cells will vent through the PRV. When sufficient electrolyte is vented, the glass matte no longer is in contact with the plates, thus increasing the internal impedance and reducing battery capacity. In some cases, the PRV can be removed and distilled water added (but only in worst case scenarios and by an authorized service company since removing the PRV may void the warranty). This failure mode is easily detected by impedance and is one of the more common failure modes of VRLA batteries.

Soft (a.k.a. dendritic shorts) and Hard shorts occur for a number of reasons. Hard sorts are typically caused by paste lumps pushing through the matte and shorting out to the adjacent (opposite polarity) plate. Soft shorts, on the other hand, are caused by deep discharges. When the specific gravity of the acid gets too low, the lead will dissolve into it. Since the liquid (and the dissolved lead) are immobilized by the glass matte, when the battery is recharged, the lead comes out of solution forming threads of thin lead metal, known as dendrites inside the matte. In some cases, the lead dendrites short through the matte to the other plate. The float voltage may drop slightly but impedance can find this failure mode easily but is a decrease in impedance, not the typical increase as in dry-out. See figure 2, Abnormal Cell.

Thermal run-away occurs when a battery's internal components melt-down in a self-sustaining reaction. Normally, this phenomenon can be predicted by as much as four months

or in as little as two weeks. The impedance will increase in advance of thermal run-away as does float current. Thermal run-away is relatively easy to avoid, simply by using temperature-compensated chargers and properly ventilating the battery room/cabinet. Temperature-compensated chargers reduce the charge current as the temperature increases. Remember that heating is a function of the square of the current. Even though thermal run-away may be avoided by temperature-compensation chargers, the underlying cause is still present.

Nickel-Cadmium failure modes

NiCd batteries seem to be more robust than lead-acid. They are more expensive to purchase but the cost of ownership is similar to lead-acid, especially if maintenance costs are used in the cost equation. Also, the risks of catastrophic failure are considerably lower than for VRLAs.

The failure modes of NiCd are much more limited than lead-acid. Some of the more important modes are:

- Gradual loss of capacity
- Carbonation
- Floating effects
- Cycling
- Iron poisoning of positive plates

Gradual loss of capacity occurs from the normal aging process. It is irreversible but is not catastrophic, not unlike grid growth in lead-acid.

Carbonation is gradual and is reversible. Carbonation is caused by the absorption of carbon dioxide from the air into the potassium hydroxide electrolyte which is why it is a gradual process. Without proper maintenance, carbonation can cause the load to not be supported, which can be catastrophic to supported equipment. It can be reversed by exchanging the electrolyte.

Floating effects are the gradual loss of capacity due to long periods on float without being cycled. This can also cause a catastrophic failure of the supported load. However, through routine maintenance, this can be avoided. Floating effects are reversible by deep-cycling the battery once or twice.

NiCd batteries, with their thicker plates, are not well-suited for cycling applications. Shorter duration batteries generally have thinner plates to discharge faster due to a higher surface area. Thinner plates means more plates for a given jar size and capacity, and more surface area. Thicker plates (in the same jar size) have less surface area.

Iron poisoning is caused by corroding plates and is irreversible.

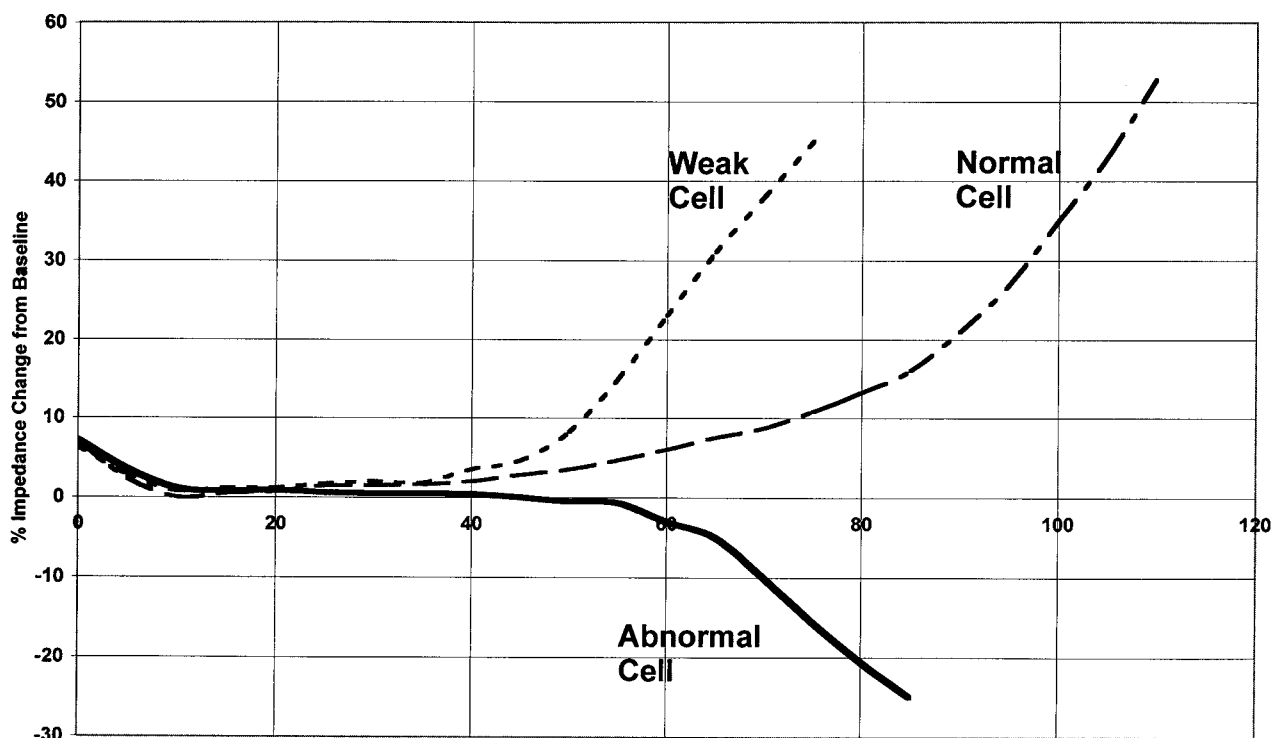

Figure 2 Changes in impedance as a result of battery capacity

Maintenance philosophies

There are different philosophies and ambition levels for maintaining and testing batteries. Some examples:

1. Just replace batteries when they fail or die. Minimum or no maintenance and testing.
Obviously, not testing batteries at all is the least costly with considering only maintenance costs but the risks are great. The consequences must be considered when evaluating the cost-risk analysis since the risks are associated with the equipment being supported. Batteries have a limited lifetime and they can fail earlier than expected. Time between outages is usually long and if outages are the only occasions the battery shows its capability risk is high that reduced or no back-up is available when needed. Having batteries as back-up of important installations without any idea of their current health spoils the whole idea of a reliable system.
2. Replace after a certain time. Minimum or no maintenance and testing.
This might also be a risky approach. Batteries can fail earlier than expected. Also it is waste of capital if the batteries are replaced earlier than needed. Properly maintained batteries can live longer than the predetermined replacement time.
3. A serious maintenance and testing program in order to ensure the batteries are in good condition, prolong their life and to find the optimal time for replacement .
A maintenance program including inspection, impedance and capacity testing is the way to track the battery's state of health. Degradation and faults will be found before they become serious and surprises can be avoided. Maintenance costs are higher but this is what you have to pay for to get the reliability you want for your back-up system.

The best testing scheme is the balance between maintenance costs and risks of losing the battery and the supported equipment. For example, in some transmission substations, there is upwards of \$10 million per hour flowing through them. What is the cost of not maintaining battery systems in those substations? A \$3000 battery is fairly insignificant compared to the millions of dollars in lost revenues. Each company is different and must individually weigh the cost-risk of battery maintenance.

How to maintain the battery

Standards and common practices

There are a number of standards and company practices for battery testing. Usually they comprise inspections (observations, actions and measurements done under normal float condition) and capacity tests. Most well-known are the IEEE standards:

- IEEE 450 for flooded lead-acid
- IEEE 1188 for sealed lead-acid
- IEEE 1106 for nickel-cadmium

IEEE 450

IEEE 450, "IEEE Recommended Practice for Maintenance, Testing and Replacement of Vented Lead-acid Batteries for Stationary Applications" describes the frequency and type of measurements that need to be taken to validate the condition of the battery. The standard covers Inspections, Capacity test, Corrective actions, Battery replacement criteria etc.

Inspections

- Monthly inspection include appearance and measurements of string voltage, ripple voltage, ripple current, charger output current and voltage, ambient temperature, voltage and electrolyte temperature at pilot cells, battery float charging current or specific gravity at pilot cells, unintentional battery grounds etc.
- Quarterly inspections include same measurements as monthly inspection and in addition voltage of each cell, battery float charging current or specific gravity of 10% of the cells or float current, and electrolyte temperature ($\geq 10\%$ of cells).
- Once a year a quarterly inspection should be extended with measurement of float charging current or specific gravity of all cells, temperature of each cell, cell-to-cell and terminal connection resistance are performed on the entire string.

Capacity test (discharge test) should be done

- At the installation (acceptance test)
- Within the first two years of service
- Periodically. Intervals should not be greater than 25% of the expected service life.

- Annually when the battery shows signs of degradation or has reached 85% of the expected service life. Degradation is indicated when the battery capacity drops more than 10% from its capacity on the previous capacity test or is below 90% of manufacturer's rating. If the battery has reached 85% of service life, delivers 100% or greater of the manufacturer's rated capacity and has no signs of degradation it can be tested at two-year intervals until it shows signs of degradations.

IEEE 1188

IEEE 1188, "IEEE Recommended Practice for Maintenance, Testing and Replacement of Valve-Regulated Lead-Acid Batteries for Stationary Applications" defines the recommended tests and frequency.

Inspections

- Monthly inspection include battery terminal float voltage, charger output current and voltage, ambient temperature, visual inspection and DC float current per string.
- Quarterly same measurements as for monthly inspection shall be done and additionally cell/unit impedance value, temperature of negative terminal of each cell and voltage of each cell. For applications with a discharge rate of one hour or less, resistance of 10% of the intercell connections shall be measured.
- Annually above measurements should be taken and in addition Cell-to-cell and terminal connection resistance of entire battery and AC ripple current and/or voltage imposed on the battery.

Capacity test (capacity test) should be done

- At the installation (acceptance test)
- Periodically. Intervals should not be greater than 25% of the expected service life or two years, whichever is less.
- Where impedance values has changed significantly between readings or physically changes has occurred
- Annually when the battery shows signs of degradation or has reached 85% of the expected service life. Degradation is indicated when the battery capacity drops more than 10% from its capacity on the previous capacity test or is below 90% of manufacturer's rating.

Battery replacement criteria

Both IEEE 450 and IEEE 1188 recommend replacing the battery if its capacity is below 80% of manufacturer's rating. Maximum time for replacement is one year. Physical characteristics such as plate condition or abnormally high cell temperatures are often determinants for complete battery or individual cell replacements.

IEEE 1106

IEEE 1106, "IEEE Recommended Practice for Installation, Maintenance, Testing and Replacement of Vented Nickel-Cadmium Batteries for Stationary Applications".

Inspections

- Inspection at least once per quarter include battery terminal float voltage, appearance, charger output current and voltage, pilot-cell electrolyte temperature.
- Semi-annually general inspection and measurement of voltage of each cell shall be done.

Capacity test (discharge test) should be done

- Within the first two years of service
- At 5-year intervals until the battery shows signs of excessive capacity loss.
- Annually at excessive capacity loss

Summary best way to test and evaluate your battery

Test intervals

1. Make a capacity test when the battery is new as part of the acceptance test.
2. Make an impedance test at the same time to establish baseline values for the battery.
3. Repeat the above within 2 years for warranty purpose.
4. Make an impedance test every year on flooded cells and quarterly on VRLA cells.
5. Make capacity tests at least for every 25% of expected service life.
6. Make capacity test annually when the battery has reached 85% of expected service life or if the capacity has dropped more than 10% since the previous test or is below 90% of the manufacturer's rating.
7. Make a capacity test if the Impedance value has changed significantly.
8. Follow a given practice (preferably from the IEEE standard) for all temperature, voltage, gravity measurements etc. and fill in a report. This will be a great help for trending and for fault tracing.

Evaluation

1. Replace cell if the impedance is more than 50% above baseline. Make a capacity test if 20-50% of baseline.
2. Replace battery if capacity test shows less than 80% of rated capacity.

Practical battery testing

The Battery testing matrix below may help guide even the most skilled battery testing technician and will help simplify the recommended practices.

The following is a description of some of the tests or maintenance parameters.

Capacity test

Capacity test is the only way to get an accurate value on the actual capacity of the battery. While used regularly it can be used for tracking the battery's health and actual capacity and estimating remaining life of the battery. When the battery is new its capacity might be slightly lower than specified. This is normal.

There are rated capacity values available from the manufacturer. All batteries have tables telling the discharge current for a specified time and down to a specific end of discharge voltage. Table below is an example from a battery manufacturer

End Volt. /Cell	Model	8 h Ah Ratings	Nominal rates at 25° C (77° F)							
			Amperes (includes connector voltage drop)							
			1 h	2 h	3 h	4 h	5 h	6 h	8 h	10 h
1.75	DCU/DU-9	100	52	34	26	21	18	15	12	10
	DCU/DU-11	120	66	41	30	25	21	18	15	13
	DCU/DU-13	150	78	50	38	31	27	23	19	16

Common test times are 5 or 8 hours and common end of discharge voltage for a lead acid cell is 1.75 or 1.80 V.

During the test it is measured how much capacity (current x time expressed in Ah) the battery can deliver before the terminal voltage drops to the end of discharge voltage x number of cells. The current shall be maintained at a constant value. It is recommended to select a test time that is approximately the same as the battery's duty cycle. Common test times are 5 or 8 hours and common end of discharge voltage for a lead acid cell is 1.75 or 1.80 V. It is recommended to use the same testing time during the battery's

Battery testing matrix – IEEE recommended practices

Instrument \ Parameter	Bite3	Bite2	DLROs	MOM/Mjölner	DCMs	BMM80	M5091	BGFT	BGL	DMA35	TORKEL	Visual
Capacity											■	
Internal ohmic value	■	■										
Intercell connection resistance	■	■	■	■								
Voltage of each cell / pilot cell	■	■					■					
Spec. grav. and temp. of each cell / pilot cell										■		
Corrosion at Terminals			■	■								■
DC Float Current	■				■							
Unintentional Battery Grounds						■		■	■			■
Battery ripple current	■				■							
Charger AC ripple. Current and Voltage					■		■					
Cycling of Ni / Cd batteries											■	
Structural integrity of rack / cabinet												■

lifetime. This will improve accuracy when trending how battery's capacity changes.

If the battery reaches the end of discharge voltage at the same time as the specified test time the battery's actual capacity is 100% of the rated capacity. If it reaches the end of discharge at 80% (8 h) or before of the specified 10 h it shall be replaced. See figure 3.

Procedure for capacity test of vented lead acid battery

1. Verify that the battery has had an equalizing charge if specified by the manufacturer
2. Check all battery connections and ensure all resistance readings are correct
3. Record specific gravity of every cell
4. Record the float voltage of every cell
5. Record the temperature of every sixth cell in order to get an average temperature
6. Record the battery terminal float voltage
7. Disconnect the charger from the battery
8. Start the discharge. The discharge current should be corrected for the temperature obtained at point 5 (not if capacity is corrected afterwards) and maintained during the entire test.
9. Record the voltage of every cell and the battery terminal voltage in the beginning of the discharge test
10. Record the voltage of every cell and the battery terminal voltage one or several times at specified intervals when the test is running
11. Maintain the discharge until the battery terminal voltage has decreased to the specified end of discharge voltage (for instance $1.75 \times \text{number of cells}$)
12. Record the voltage of every cell and the battery terminal voltage at the end of the test. The cell voltages at the end of the test have special importance since weak cells are indicated here.
13. Calculate the actual battery capacity

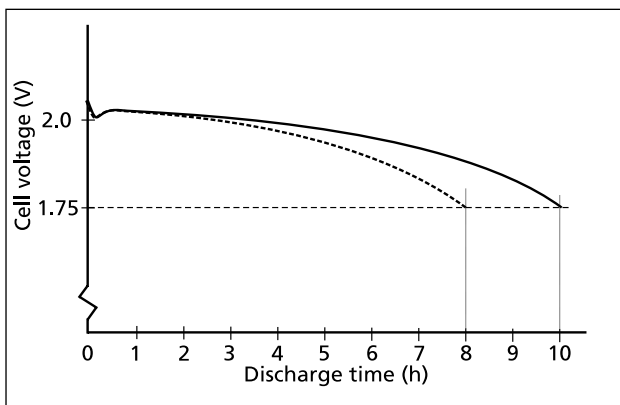

Figure 3 If the battery reaches the end of discharge at 80% (8h) or before of the specified 10 h it shall be replaced.

It is important to measure the individual cell voltages. This has to be made a couple of times during the test. Most important is to measure the cells at the end of the discharge test in order to find the weak cells.

It is also very important that the time OR the current during a discharge test is adjusted for the temperature of the battery. A cold battery will give less Ah than a warm. Temperature correction factors and methods are described in the IEEE standards.

Manufacturers can also specify their batteries at constant power discharge. This is used where the load has voltage regulators. Then the current will increase when the voltage drops. Procedure for testing these batteries is the same but the load equipment must be able to discharge with a constant power.

Batteries can also be tested at a shorter time than their duty cycle, for instance at 1 hour. Then the current rate has to be increased. Advantage is that less capacity is drained from the battery (valid for lead-acid) and it requires less time to recharge it. Also less man-hour is needed for the test. Contact your battery manufacturer for more information. At higher rates it is more important to supervise the battery's temperature.

Between load tests, impedance measurement is an excellent tool for assessing the condition of batteries. Furthermore, it is recommended that an impedance test be performed just prior to any load test to improve the correlation between capacity and impedance.

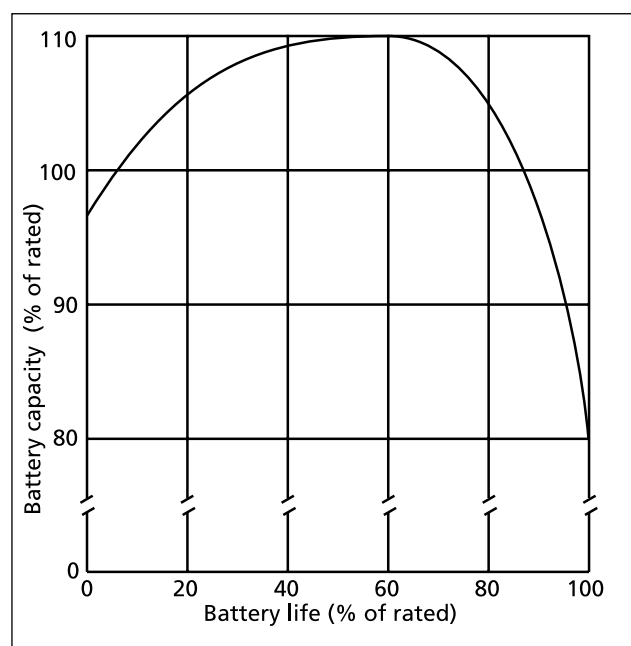

Figure 4 Replacement of battery is recommended when the capacity is 80% of rated.

Impedance test

Impedance, an internal ohmic test, is resistance in AC terms. With regard to DC battery systems, impedance indicates the condition of batteries. Since it tests the condition of the entire electrical path of a battery from terminal plate to terminal plate, impedance can find weaknesses in cells and intercell connectors easily and reliably.

Basically, impedance test is determined by applying an AC current signal, measuring the AC voltage drop across the cell or intercell connector and calculating the impedance using Ohm's Law. In practice, not only is the AC voltage drop measured but so is the AC current. The AC current is measured because of other AC currents in a battery that are additive (subtractive). Other AC currents are present from the charger system. The test is performed by applying an AC test signal to the terminal plates. Then measure both the total AC current in the string and the voltage drop of each unit in the string by measuring each cell and intercell connector consecutively until the entire string is measured. The impedance is calculated, displayed and stored. As the cells age, the internal impedance increases as depicted in figure 2. By measuring impedance, the condition of each cell in the string can be measured and trended to determine when to replace a cell or the string which helps in planning for budgetary needs.

The impedance test is a true four-wire, Kelvin-type measurement that provides excellent reliability and highly reproducible data on which to base sound decisions with regard to battery maintenance and replacement. Impedance is able to find weak cells so that proactive maintenance can be performed. After all, the battery is a cost but it is supporting

a critical load or revenue stream. If a single cell goes open then the entire string goes off line and the load is no longer supported. Therefore, it is important to find the weak cells before they cause a major failure.

The graph in figure 5 shows the effect of decreasing capacity on impedance. There is a strong correlation between impedance and capacity so that weak cells are ably and reliably found in sufficient time to take remedial action. The graph shows the reorganized impedance data in ascending order with each cell's corresponding load test end voltage. (Impedance in milliohms coincidentally is the same scale as the voltage, 0 to 2.5). This view, that is ascending impedance/descending voltage, groups the weak cells on the right side of the graph to find them easily.

Impedance theory

A battery is not simply resistive. There is also a capacitive term. After all, a battery is a capacitor, a storage device, and resistors cannot store electricity. figure 6 shows an electrical circuit, known as the Randles Equivalent Circuit, that depicts a battery in simple terms. There are those who would have people believe that the capacitive term is not necessary and that the resistance is the only part that needs measuring.

Impedance measures both the DC resistance (the real component in impedance) and the reactance (the imaginary components in impedance). Only by measuring both can the capacitive term start to be understood. The other argument used against impedance is that frequency is a variable in the reactance part of the impedance equation. That is true except that since Megger uses a fixed frequency, namely 50 or 60 Hz depending upon geography, it is always

Ascending Impedance with Corresponding End Voltage

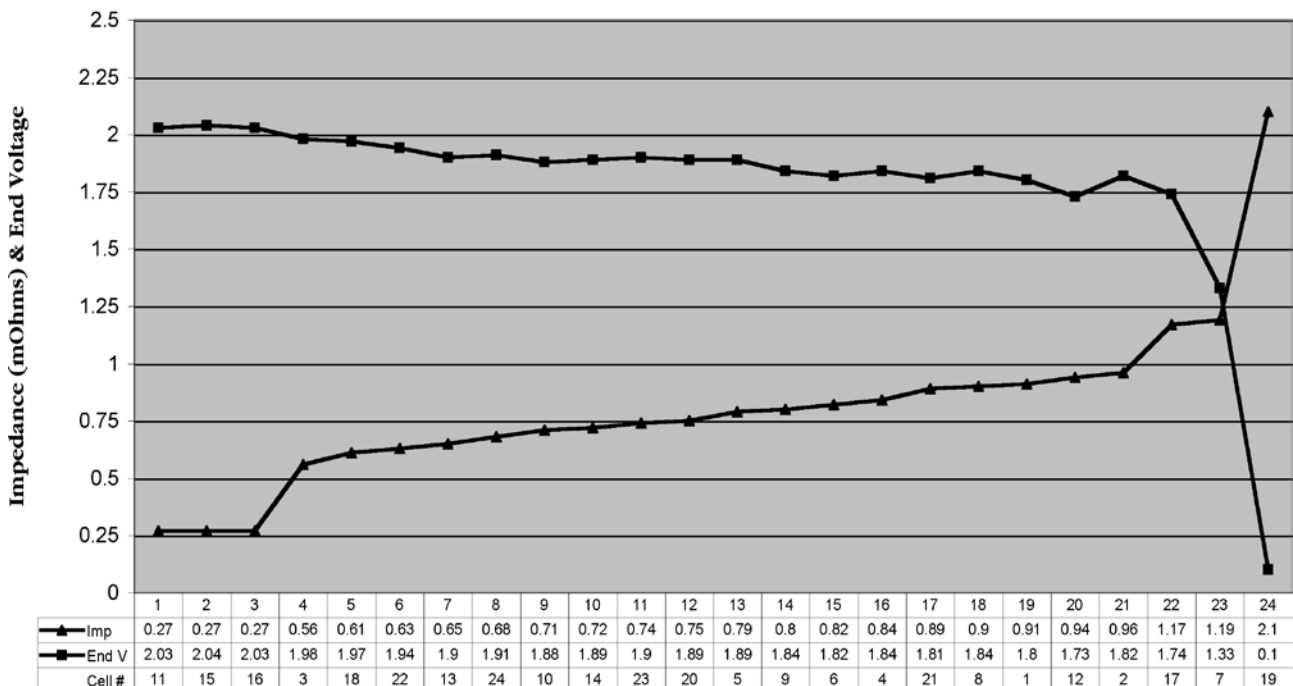

Figure 5 Ascending impedance with corresponding end voltage

the same. This variable, $2\pi\omega$, now becomes a constant and, therefore, frequency does not affect the final result in any way. The only parts that affect the final result are the parts that vary within the battery, namely resistance and capacitance, which paint the whole capacity/condition picture.

In the diagram shown in figure 6, R_m is the metallic resistance, R_e is the electrolyte resistance, R_{ct} is the charge transfer resistance, W_i is the Warburg impedance and C_{dl} is the capacitance of the double layer. R_m includes all of the metallic components one post to the other post, i.e., post, top lead and grids and to a certain degree, the paste. R_e is the resistance of the electrolyte which doesn't vary that much on a bulk basis. But at the microscopic level in the pores of the paste, it can be significant. R_{ct} is the resistance of the exchange of ions from the acid to the paste. If the paste is sulphated, then R_{ct} increases or if that portion of the paste is not mechanically (electrically) attached to the grid so that electrons cannot flow out of the cell. Warburg impedance is essentially insignificant and is a function of the specific gravity. C_{dl} is what probably makes the most important contribution to battery capacity. By only measuring DC resistance, capacitance, an important part of the cell, is ignored. Impedance measures both DC resistance and capacitance.

A battery is complex and has more than one electrochemical process occurring at any given time, e.g., ion diffusion, charge transfer, etc. The capacity decreases during a discharge due to the conversion of active material and depletion of the acid. Also, as the plates sulphate, the resistance of the charge transfer increases since the sulphate is less conductive than the active material. (See discussion about the differences between the thickness of the plates in long-duration versus short-duration batteries.)

Intercell connection resistance

Intercell connection resistance is the other half of the battery. A battery is comprised of cells connected in a series path. If any one component fails the entire series connection fails. Many times batteries fail, not because of weak cells, but due to weak intercell connections, especially on lead posts which can cold-flow. Generally, hardware should be tightened to the low end of the torque scale that is recommended by the battery manufacturer. But torque wrenches are a mechanical means to verify low electrical resistance. It is far better to actually perform an electrical test using an appropriate instrument. It is a low electrical resistance that

is desired. This test should be performed before the battery is commissioned. Proper intercell connections are necessary to ensure that discharge rates can be met. The instrument of choice is a DLRO® or a MOM which can easily verify that all connections have been made properly. It can even find minor errors before the battery is commissioned, preventing possible causes of failure or damage to supported equipment.

Testing intercell connection resistance performs two functions:

- Validates intercell connection resistance
- Finds possible gross errors with top lead internal to the cell

By following IEEE Recommended Practices, intercell connection resistance can be validated. Those recommended practices specify that the variation of intercell connection resistance be less than ten percent. This translates into 7 micro-ohms on a 70-micro-ohm intercell connection resistance. This method can even find a washer stuck between the post and the intercell connector whereas torquing will not. They also specify that ten percent of the intercell connectors be measured quarterly and all intercell connectors annually.

In multiple post batteries, it is possible to find those rare gross errors in a cell's top lead. (See multiple post battery diagram in figure 1). On multiple-post cells, measure straight across both connections, then measure diagonally to check for balance in the cell and connections. Measuring only straight across does not adequately test for either intercell connection resistance or for gross top lead defects. This is due to the parallel circuits for the current.

The graph in figure 7 shows the data obtained from an actual 24-cell telephone (CO) battery. The peak at connector #12 (cell 12 to 13) is an intertier cable connection. Connector #3 was out of specification and it was determined that one of the two bolts was not properly torqued. It was retorqued and retested. It came within ten percent of the string average after retorquing.

The negative plates (odd-numbered plates #1 through 15) are all connected through negative top lead which is connected to both negative posts. Positive plates (even-numbered) are connected to each other through positive top lead which is connected to both positive posts. There are two intercell connectors between neg post 1 and pos post 1 and between neg post 2 and pos post 2.

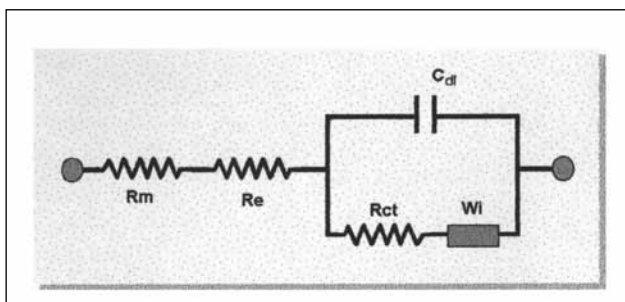

Figure 6 Randles equivalent circuit

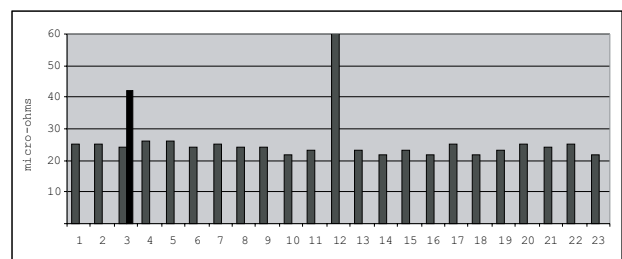

Figure 7 Intercell connection resistance bar graph

The higher the current draw the more critical is the proper sizing of current-carrying components both internal to the cell and external. UPS batteries are usually designed for a high rate discharge lasting typically only 15-20 minutes. However, a telecommunications CO battery may have only a 500 Amp draw but can discharge for up to eight hours. So either combination can have disastrous effects due to improperly sized and maintained cells and intercell connectors.

Testing and electrical paths

In order to properly test a multiple post cell, one must understand its construction. Based on the diagram in figure 1, it can be seen that there are two parallel paths for the test current to travel. If the test leads are placed on neg post 1 and pos post 1, the two parallel paths are (1) directly from neg post 1 to pos post 1 through their intercell connectors and (2) neg post 1 down to the top lead, up to neg post 2 and across the intercell connectors to pos post 2 down to the pos top lead and back up to pos post 1. The two paths are parallel circuits and hence indistinguishable. If one bolt is loose, there isn't any way to determine that since the test current will follow the path of least resistance. The better method to measure intercell connection resistance is to measure diagonally from neg post 1 to pos post 2 and again from neg post 2 to pos post 1. Compare the two readings for highest confidence. Admittedly, diagonal measurements are still parallel but the comparison becomes more interesting due to the increased influence of top lead and loose hardware. Diagonal measurements do not allow for a direct connection from post to post. In the case of six-post cells, measure diagonally across the farthest posts in both directions.

Voltage

Float voltage has traditionally been the mainstay of any testing procedure. What is voltage? Voltage is the difference, electrically speaking, between the lead and the lead oxide on the plates or between the nickel and the cadmium. The charger is the item that keeps them charged. The sum of all of the cell voltages must be equal to the charger setting (except for cable losses.) This implies then that voltage merely indicates the state-of-charge (SOC) of the cells. There is no indication of a cell's state-of-health (SOH). A normal cell voltage doesn't indicate anything except that the cell is fully charged. An abnormal cell voltage, however, does tell you something about the condition of the cell. A low cell voltage can indicate a shorted cell but only when the voltage finally drops to about 2.03. If a cell is low then other cells must be higher in voltage due to the charger setting. Remember that the sum of all cell voltages must equal the charger setting. Those cells that are higher are counteracting the low cell and generally speaking the higher cells are in better condition because they can tolerate the higher voltage. But those cells are being overcharged which over-heats them and accelerates grid corrosion and water losses.

Let's say for the moment that the low voltage cell is not yet at 2.03, it is at 2.13 V. At 2.13 V it is not low enough to flag a concern but it is degrading. It may or may not be able to

support the load when an outage occurs. Impedance is able to find that weak cell sooner than voltage. In this case, impedance will decrease since it is an impending short circuit.

A similar example can be found in VRLA when it comes to dry-out or loss-of-compression. Voltage will not find this condition until it is far later in the battery's life, until it is too late. Impedance finds this condition much earlier so that remedial action can be performed.

So don't confuse fully charged with full capacity.

As said above, cell voltage divergence can be caused by a number of factors and one way to solve this problem could be to make an equalization charge. In an equalization charge procedure, the entire battery is charged at a higher (than normal) voltage for several hours to balance the voltage in all the cells. The procedure can lead to heating and possibly water loss. It is recommended to follow the manufacturer's procedure to avoid damaging the battery.

Specific gravity

Specific gravity is the measure of the sulphate in the acid of a lead-acid battery. It is also the measure of the potassium hydroxide electrolyte in nickel-cadmium battery but since the potassium hydroxide electrolyte isn't used in the chemical reaction, it is not necessary to measure it periodically.

Specific gravity traditionally has not provided much value in determining impending battery failure. In fact, it changes very little after the initial 3 to 6 months of a battery's life. This initial change is due to the completion of the formation process, which converts inactive paste material into active material by reacting with the sulphuric acid. A low specific gravity may mean that the charger voltage is set too low causing plate sulphation to occur.

In a lead-acid battery the sulphate is a closed system in that the sulphate must be either on the plates or in the acid. If the battery is fully charged then the sulphate must be in the acid. If the battery is discharged, the sulphate is on the plates. The end result is that specific gravity is a mirror image of voltage and thus state-of-charge. Specific gravity readings should be taken when things are amiss in the battery to obtain as much information about the battery as possible.

Different battery applications and geographies have varying specific gravities to accommodate rates, temperature, etc. Following is a table that describes some applications and their specific gravities.

Specific gravities and their applications

Specific gravity	Percent acid	Application
1.170	25	Tropical stationary
1.215	30	Standard stationary
1.250	35	UPS/high rate
1.280	38	Automotive
1.300	40	VRLA stationary
1.320	42	Motive power
1.400	50	Torpedo

Float current

Another leg of the Ohm’s Law triangle is current. The charger voltage is used to keep a battery charged but voltage is really the vehicle to get current into the battery (or out of it during discharge). It is current that converts the lead sulphate back to active material on the grids.

There are two types of DC current on a battery: recharge current which is the current applied to recharge a battery after a discharge and float current which is the current used to maintain a battery in a fully charged state. If there is a difference between the charger setting and the battery’s voltage, that difference will cause a current to flow. When the battery is fully charged [1], the only current flowing is the float current which counteracts the self-discharge of the battery (<1% per week). Since the voltage differential between the charger and the battery is small, the float current is small. When there is a large voltage difference such as after a discharge the current is high and is limited by the charger until the voltage difference becomes less. When the current is on the plateau in the graph below, this is called current limit. When the voltage differential becomes less, the charge current is reduced as depicted on the downward sloping charge current line on the graph shown in figure 8. The charge voltage is the voltage of the battery, not the charger setting which is why it is increasing.

Float current will vary with battery size. The larger the battery is, the more float current it will take to keep it fully charged. Float current can increase for a couple of reasons: ground faults on floating battery systems and internal battery faults. Ground faults are discussed later. As a battery’s internal impedance increases, it takes more current to pass through that higher impedance. The increase in float current can be an indicator of battery faults. In lieu of measuring float current, many of the same conditions are found with impedance.

In VRLA batteries, float current [2,3] seems to be an indicator of battery problems, namely thermal runaway. Thermal runaway is the result of a battery problem, not the cause. Some of the causes that can lead to thermal runaway are shorted cells, ground faults, dry-out, excessive charging and insuf-

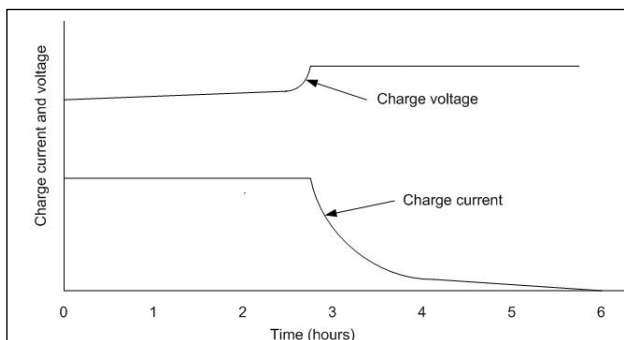

Figure 8 Constant-voltage Constant-current charge characteristics

ficient heat removal. This process takes anywhere from two weeks to four months to occur once the float current starts its increase. By measuring float current, it may be possible to avoid catastrophic failure of the battery and damage to connected and nearby equipment. Impedance will find many of these same errors.

Ripple current

Batteries, as DC devices, prefer to have only DC imposed on them. The charger’s job is to convert AC into DC but no charger is 100% efficient. Frequently, filters are added to chargers to remove the AC current from the DC output. The AC current on the DC is called ripple current. Battery manufacturers have stated that more than about 5 A rms of ripple for every 100 Ah of battery capacity can lead to premature failure due to internal heating. Ripple voltage is not a concern since it is the heating effect of the ripple current that damages batteries. The 5% ripple current figure is a rough estimate and depends also on the ambient temperature. Ripple current can increase slowly as the electronic components in the charger age. Also if a diode goes bad, the ripple current can increase more dramatically leading to heating and premature death without anyone knowing it. Although impedance is not a measure of ripple current, ripple current is measured because of the way Megger designs its impedance instruments.

There is anecdotal evidence [4] that low frequency ripple (<10Hz) may charge and discharge a battery on a micro-scale. More research is necessary to prove this hypothesis. Excessive cycling can lead to premature death of a battery regardless of the reasons for the cycling, be they outages, testing or maybe micro-cycling. One thing is true: the lower the AC is on the battery system, the less the damage is that can occur. VRLA batteries seem to be more sensitive to ripple current than their flooded counterparts. It is then advisable to filter their chargers for ripple current/voltage.

Temperature

It is well known that low temperatures slow up the internal chemical reactions in any battery; the degrees of reduced performance vary according to the technology. For example, at temperatures around freezing, a VRLA may need capacity compensation of 20%. The lead-calcium cell using 1.215 specific gravity acid will require a doubling of capacity, while the Ni-Cd will need about 18% increased capacity.

At the other end of the temperature range, high temperature is the killer of all batteries. There will be no surprise to find out that this impact varies from one technology to another. Lead acid at 95 °F will experience a 50% shortened life, while Ni-Cd will have a 16-18% shortening of life.

By applying what Arrhenius learned about chemical reactions, for every 18° F (10° C) increase in battery tem-

[1] Cole, Bruce, et al., Operational Characteristics of VRLA Batteries Configured in Parallel Strings, GNB Technologies
 [2] Brown, AJ, An Innovative Digital Flat Current Measurement Technique - Part Two, Proceedings of BattConn@ 2000
 [3] Boisvert, Eric, Using Float Charging Current Measurements to Prevent Thermal Runaway on VRLA Batteries, Multitel
 [4] Ruhlmann, T., Monitoring of Valve Regulated Lead Acid Batteries, Proceedings of BattConn@ 2000

perature, battery life is halved, battery life can start to be managed. The increased temperature causes faster positive grid corrosion as well as other failure modes. By holding a lead-acid battery at a temperature of 95° F (35° C) instead of the designed 77° F (25° C), a 20-year battery will last only ten years, a ten-year battery only five years and so on. Increase the temperature by another 18° F to 113° F (45° C), a 20-year battery will last only five years!

A battery is rarely held at a certain temperature for its entire life. A more realistic scenario is for a battery to heat during the day and cool down at night with higher average temperatures in the summer and lower average temperatures in winter. It is unfortunate but cooling the battery off to below 77° F (25° C) will not gain back the life that was lost. Once the positive grid corrodes, it cannot be converted back again. Furthermore, positive grid corrosion occurs at all temperatures, it is merely a matter of speed of the corrosion rate. The end result is to control, as best as possible (back to cost versus risk), the temperature of the batteries in the network.

IEEE 450, Annex H offers a method for calculating the impact of high temperatures on a lead acid battery.

Data analysis

The essence of any testing methodology is how to interpret the data to make some sense of it all. The same is true of battery testing. If the data are to be hand-written and filed or if a printout from an instrument is reviewed then filed, then there is no useful analysis except if there is an emergency at that very moment. The real value in battery testing lies in the trending of data to determine if problems are imminent or a little farther out. Trending of battery data, especially impedance and capacity, is an excellent tool for budgetary planning. By watching the batteries degrade over time, a decision can be made as to when to replace a battery. With trending, emergency replacements decrease dramatically.

The first time a battery's impedance is tested can cause concern because there is no baseline. In these cases, it is good to compare each cell against every other cell in the string. Weak cells stand out. It is these cells which require further investigation. The table below provides a guideline depending upon the length of time batteries have been tested.

	Single Test	Trending	
	% Deviation from String Avg	Cell's % Change from Last Test	Cell's % Change Overall
Lead-acid, Flooded	5	2	20
Lead-acid, VRLA, AGM	10	3	50
Lead-acid, VRLA, Gel	10	3	50
NiCd, Flooded	15	10	100
NiCd, Sealed	15	5	80

Locating ground faults on DC systems without sectionalizing

Overview

The main objective of a battery system is to provide standby and emergency power to operate industrial, consumer, commercial or protective devices. Some of these devices include emergency lighting units, uninterruptible power supplies, continuous process systems, operating controls, switchgear components and protective relays.

In emergency situations, it is essential that these devices be in proper operating condition. Failure of a DC system or the battery can result in operational failure of the devices connected to that system. System failure can lead to loss of revenue, damage to equipment and/or injured personnel.

It is a common situation for a floating DC system to develop grounds within it. When a battery system is partially or completely grounded, a short circuit is formed across the battery and consequently may cause the protective device to fail to operate when needed.

Current test methods

Traditionally utilities and industrial complexes have gone to great lengths to find ground faults within their battery systems. However, locating these battery grounds proves to be a very elusive and time-consuming process. The current ground-fault location method involves sectionalizing, or interruption, of DC branches to isolate the ground fault. Sectionalizing disables the system protection and has been known to cause inadvertent line and generator tripping. For this reason, many utilities have banned sectionalizing. Until more recently, though, this had been the only method available to locate ground faults.

A better test method

Developments have led to a better test method; injecting a low-frequency AC signal and using that AC signal to locate the ground in the DC system. This method can be performed without sectionalizing the DC system and it reduces the fault locating time from days to hours. Furthermore, it allows for system protection to be present at all times.

The AC injection method measures single or multiple ground faults by first injecting a low-frequency, 20 Hz AC signal between the station ground and the battery system. Second, the resulting current is then measured by using a clamp-on sensing current transformer. From this, the resistance value can be calculated using the in-phase component of the circulating current, thus rejecting the effect of capacitive loads. Therefore, if the signal is injected at the battery terminal and the clamp-on CT is connected to the outgoing lead, the instrument will measure the total ground resistance present on the battery system. If the CT is clamped on a feeder, then the instrument will measure the

ground resistance on that feeder. Faults can be traced easily regardless of the number of distribution panels or circuits because the “tracer” is merely following the strength of the AC signal. System integrity is maintained because it is an on-line AC test and is designed to prevent system trips.

After injection of a low-frequency AC waveform, a resistive fault on a branch of the battery system will be indicated by a low-resistance value. For example, if the total resistance of a battery system showed 10 k Ω , this would indicate a resistive fault on the battery system. The resistive fault can be located by clamping on each individual circuit until a resistive value of 10 k Ω is found.

It is easy to see that this method can be adapted in a straight forward manner to locate multiple faults by using the theory of parallel paths. For example, if the total system resistance indicates 1 k Ω and an individual branch indicates 10 k Ω resistive fault, the user would know that the system has a second fault because the total system resistance and the branch resistance do not match. By using the AC injection method, ground faults on ungrounded DC systems is easy, straight-forward and safe.

Frequently asked questions

What does float voltage of a cell tell me?

Float voltage indicates that the charger is working, that is, state-of-charge. It does not indicate the state-of-health (condition) of the cell. It indicates that the cell is fully charged, but don't confuse fully charged with full capacity. There have been many times that the float voltage is within acceptable limits and the battery fails. A low float voltage may indicate that there is a short in the cell. This is evident by a float voltage at about 2.06 or below for lead-acid (if the charger is set for 2.17 V per cell)

In some cases, a cell floats considerably higher than the average. This may be caused by the high float voltage cell compensating for another cell that is weak and is floating low. It is possible that one cell floats much higher to compensate for several cells floating a little low. The total of all cells' voltages must equal the charger setting.

What are the recommended maintenance practices for the different types of batteries?

IEEE Recommended (Maintenance) Practices cover the three main types of batteries: Flooded Lead-acid (IEEE 450), Valve-Regulated Lead-acid (IEEE 1188) and Nickel-Cadmium (IEEE 1106). Generally speaking, maintenance is essential to ensure adequate back-up time. There are differing levels of maintenance and varying maintenance intervals depending upon the battery type, site criticality and site conditions. For example, if a site has an elevated ambient temperature, then the batteries will age more quickly implying more frequent maintenance visits and more frequent battery replacements.

How important is intercell connection resistance?

Our experience has found that many battery failures are due to loose intercell connections that heat up and melt open rather than from cell failure. Whether a cell is weak or an intercell connector is loose, one bad apple does spoil the whole bushel.

When lead acid batteries are frequently cycled, the negative terminal may cold flow, thus loosening the connection.

The proper sequence of measuring multiple post batteries is critical. Not all instruments provide valid intercell connection resistances due to their method of testing. Megger instruments provide valid data.

What are some common failure modes?

Failure mode depends upon the type of battery, the site conditions, application and other parameters. Please refer the summary on pages 7-8 or to the "Battery Failure Modes," which can be found on the Megger website. Look under the Battery Test Equipment product section. In the upper right-hand column under "Documents click for Application Guides, Articles and FAQs.

How often should impedance readings be taken?

The frequency of impedance readings varies with battery type, site conditions and previous maintenance practices. IEEE 1188 Recommended Practices suggests that a baseline shall be taken six months after battery has been in operation and then semi-annual quarterly. With that said, Megger recommends that VRLA batteries are measured quarterly due to their unpredictable nature and semi-annually for NiCd and flooded lead-acid. Impedance reading should also be taken prior to every capacity test.

At what point should I stop changing cells and replace the entire battery?

In shorter strings (less than 40 cells/jars), the entire should be replaced when three to five units have been replaced. In longer strings, a similar percentage that is replaced is the criterion.

How can I predict when I need to change a cell?

Even though there is not a perfect mathematical correlation between battery capacity and impedance (or any other battery test except a load test), the amount of increase in impedance is a strong indicator of battery health. Megger has found that a 20 percent increase in impedance for flooded lead-acid generally correlates to 80% battery capacity. In VRLA, that increase is closer to 50% from the battery's initial impedance or from the manufacturer's baseline values.

Will capacity testing destroy my battery?

The battery system is designed to provide back-up power during all outages that appear during its lifetime. Performing a capacity test is nothing else than simulating one outage but in a controlled way. Batteries can normally be deep discharged (discharged to manufacturer's end-of discharge voltage) 100 - 1000 times depending on type of battery. Using a few of these cycles has no real impact on the battery's lifetime. On the other hand there is no reason to test more frequently than recommended by the standards.

Can I make a discharge test while my battery is still connected to the load (on-line)?

Yes it is possible to do. Megger has test equipment that automatically senses and regulate the discharge current even when the batteries are connected to the ordinary load. Most users choose to make a 80% discharge test when on-line in order to still have some backup time at the end of the test.

Battery technology summary

As you can see, there is a lot to a battery. It is a complex electro-chemical device. There is much more information available that goes further into the details of Tafel curves and depolarization but that is beyond this scope. Essentially, batteries need maintenance and care to get the most of them which is the main reason people spend so much on batteries – to support far more expensive equipment and to ensure continuous revenue streams.

Megger products overview

Megger offers solutions to ensure system performance with its comprehensive line of Battery Test Equipment, Low Resistance Ohmmeters and Micro-ohmmeters, Insulation Testers, and Multimeters.

An overview of the various products available is described below. For more information on these and many other Megger products, please contact us at (800) 723-2861, (214) 333-3201. Visit our web site www.megger.com for the most up-to-date news, product and service information.

Impedance test equipment

Regardless of whether you are testing flooded lead-acid, VRLA or Ni-Cd cells, Megger has the right equipment for your battery maintenance requirements. The products and associated accessories provides meaningful data on battery health without significant expense or any reduction in remaining battery capacity.

Interruption in service can cause disaster to supported equipment and facilities. Consequently, a dependable backup power system is critical so that when AC mains fail, costly service interruptions can be avoided. The battery impedance test helps to identify weak cells before they cause problems.

Taking the battery off-line for testing is time consuming and adds risk to the process. This process is unnecessary with the on-line testing capabilities of the Megger family of battery test products. The highly repeatable instruments help reduce downtime.

BITE® 3



- Determines the condition of lead-acid batteries up to 2000 Ah
- On-line testing with Pass/Warning/Fail calculations
- Measures impedance, intercell connection resistance, cell voltage
- Windows CE™ Operating System with more than 16 MB of memory
- Measures float and ripple currents

The BITE 3 is a compact, battery-operated, instrument with powerful on-board data analysis tools. It is the first of its kind instrument in that the ProActiv can download all previous data to provide the best in on-site data analysis like no other instrument of its kind. The menus are easy to navigate with a bright, backlit LCD. The data display includes the normal numeric arrangement but adds two graphical displays to help analyze weak cells.

BITE® 2 and BITE®2P



- Determines the condition of lead-acid and nickel-cadmium batteries up to 7000 Ah
- On-board Pass/Warning/Fail indications
- On-line testing
- Robust, reliable instruments
- Built-in printer (BITE 2P)

The BITE 2 and BITE2P Battery Impedance Test Equipment work by applying a test current across the battery string while on-line, then measuring the impedance, cell voltage and intercell connection resistance. They also measure ripple current which indicates the condition of the charger. The instruments help evaluate the condition of the entire string from terminal plate to terminal plate and even the charger.

ProActiv battery database management software

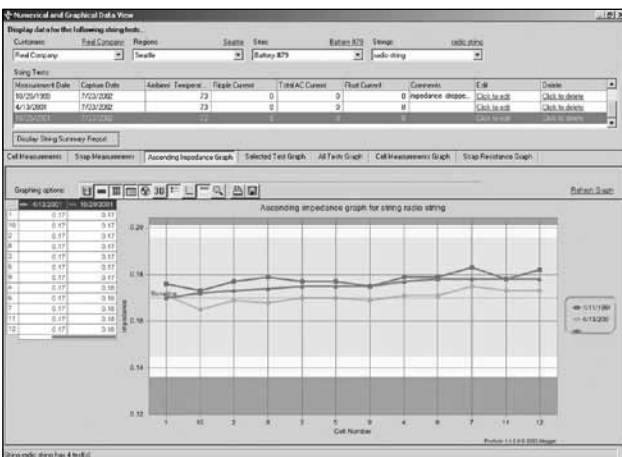

- Organizes and manages battery data
- Performs trending analysis
- Assists the user to manage multiple batteries
- Prints basic reports

The first of its kind, ProActiv is a new, powerful, easy to use battery database management software designed to analyze each individual battery in a battery system.

Battery testing is crucial to ensure a battery system provides standby and emergency power to operate devices such as emergency lighting, UPS systems, operating controls, switchgear components, protective relays and continuous process systems. Failure of a battery system within environments such as utilities, hospitals or manufacturing plants can result in operational failure of the devices connected to it. ProActiv assists the user to avoid battery failures, budget for future battery string and cell replacements, and plan battery change outs in an orderly manner.

ProActiv utilizes a standard MS Access database format. It allows the user to organize and manage battery data such as voltages, impedance, intercell connection resistance, ripple current, specific gravity, IR thermographs and more.

BITE® accessories

- Enhances the capabilities of the BITE line
- Full line of accessories
- Designed for unique situations
- Great for non-standard installations

Megger offers a complete line of accessories to enhance the capabilities of the BITE product line. Many are shown in the Data Sheet link above, but there are many others including extension cables, calibration shunts, etc. Even though we have many accessories, we are continually evaluating additional products as interest arises.

RopeCT™ is a flexible, highly accurate current transmitter for measuring current flow in larger battery systems. It comes in two lengths: 24 in. (60 cm) and 36 in. (90 cm) for 8 in. (20 cm) and 12 in. (30 cm) diameters, respectively. It is designed specifically for the BITE 2, BITE2P and EBITE.



Mini-CTs are for measuring current in smaller gauge wires and a single cable tied in a bundle.



The Current Transformer kit for the BITE 3 is for measuring the current in noisy battery systems and to measure "escape current" in parallel battery strings. Competitive instruments do not measure current and then, may provide erroneous internal ohmic values.



Lighted Probe Extensions can be mounted on the receivers and probes of the BITE 3, BITE 2 and BITE 2P. They are ideal for measuring batteries in cabinets and hard-to-reach places. With these probe extensions, batteries needn't be taken off line to measure them – a real time and cost saving device.



The BITE 3 offers alternative lead sets for measuring ELUs and other smaller battery applications, spade terminal batteries and batteries with harnesses. They facilitate measuring the impedance of battery systems with difficult access.



Digital Hydrometer measures specific gravity and temperature for each cell and it calculates a temperature-adjusted specific gravity to save time – all in a hand-held device. It can store up to 256 cells per string in up to eight strings. No need to worry about parallax or hand writing data on sheets, etc. It is much safer than bulb hydrometers and without any spilled acid to clean up.



Capacity testing

TORKEK 820/840/860



- Batteries can be tested "in service"
- Unit adjusts to include load currents in the test parameters
- User adjustable alarm and shutdown points to avoid excessive discharge

Batteries in power plants and transformer substations must provide the equipment they serve with standby power in the event of a power failure. Unfortunately, however, the capacity of such batteries can drop significantly for a number of reasons before their calculated life expectancy is reached. This is why it is so important to check batteries at regular intervals, and the only reliable way of measuring battery capacity is to conduct a discharge test.

The TORKEK instruments are used for discharge testing. Tests can be conducted at constant current, constant power, constant resistance or in accordance with a pre-selected load profile. For extra discharge capacity there are auxiliary load units available.

TORKEK 820 can discharge batteries ranging from 12 to 48 volts with currents up to 270 A

TORKEK 840 is used for battery systems ranging from 12 to 250 V.

TORKEK 860 is designed for users who travel from place to place to maintain battery systems having different voltages. It features excellent discharging capacity plus a broad voltage range and outstanding portability. The TORKEK 860 is used for systems ranging from 12 to 480 V.

TORKEK accessories

TORKEK Win is a software for report functions and remote control of TORKEK.

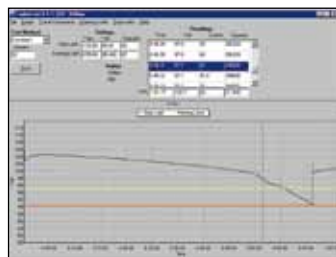

TXL830/850/870 are extra load units for providing higher load currents. Together, TORKEK and the TXL extra loads form a system that can discharge batteries with currents up to several kA.



Ground fault tracing equipment

There are two ground fault locating instruments from which to choose, the Battery Ground Fault Tracer (BGFT) and the Battery Ground-Fault Locator (BGL). The BGFT has superior noise elimination while the BGL has an automatic bridge to differentiate between high capacitance and low resistance. Here is a brief description of each instrument.

Battery Ground Fault Tracer (BGFT)

- Easily locates ground faults in ungrounded DC battery systems
- Operates in high electrical noise environment
- Simplifies fault tracing by identifying fault characteristic (resistive and capacitive) magnitudes

The Battery Ground-Fault Tracer is an economical, manually balanced instrument that identifies, tracks and locates ground faults in ungrounded DC battery systems - on-line. It is particularly effective in high electrical noise environments, as the strength of the test current can be adjusted up to 80W. The BGFT is particularly useful in any industry where supply of power for operating measurement, communication and control equipment is critical.

The Battery Ground-Fault Tracer accelerates fault location by eliminating trial-and-error procedures and because faults can be located without going off-line. It is line operated and has a manual bridge. The manual bridge is used to differentiate between true, resistive faults and phantom, capacitive faults by using a feedback cable to null the capacitance. But the manual bridge is not required in order to trace faults.

The BGFT works by converting line frequency to 20 Hz. It then pushes the AC signal through some coupling capacitors to prevent transients on the DC buss and applies the AC signal into the DC system while on-line. Using the hand-held tracer, follow the signals with the highest readings until the fault is found.

Battery Ground-fault Locator (BGL)

- Ground faults in ungrounded DC battery systems are easily located
- Features an automatic bridge
- Battery operated
- Simplifies fault tracing by identifying fault characteristic (resistive and capacitive) magnitudes

The Battery Ground-Fault Locator was developed to detect, track and locate ground faults on battery systems, without resorting to sectionalizing! The BGL tracks and locates ground faults on live or dead battery systems. To save hours of unnecessary troubleshooting, the BGL readily differ-

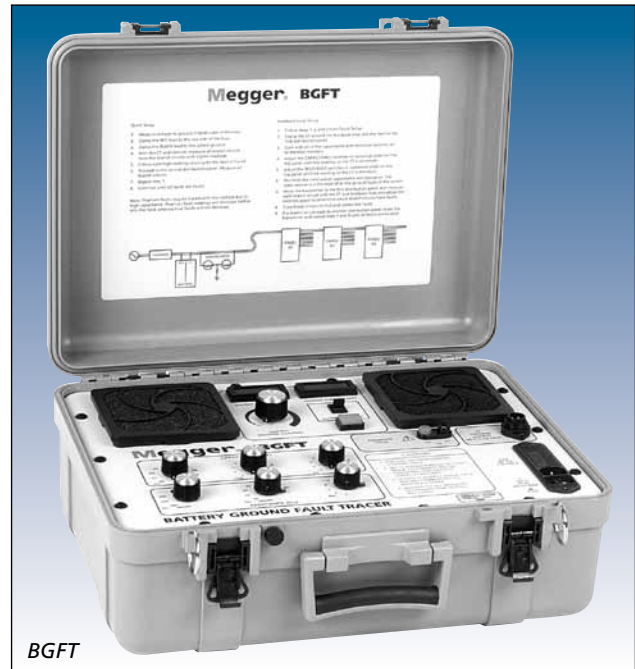

BGFT



BGFT



BGL

entiates between the resistive fault currents and capacitive charging currents. This feature allows the instrument to detect and track leakage paths, even in the presence of surge-suppression capacitors.

The BGL works by filtering and applying an AC signal to the DC buss on-line. The low level output of the BGL allows it to be battery-operated but is more sensitive to system noise. It has a built-in automatic bridge to differentiate between real (resistive) and phantom (capacitive) faults so only the real faults are traced. The BGL is moved from panel to panel to continue the tracing process until the fault is found. Since it has an automatic bridge it is very easy to trace faults and as such is better designed for the novice user.

Digital Low Resistance Ohmmeters (DLRO) and Microhmmeters (MOM)

Many times batteries fail not because of weak cells but due to weak intercell connections. Torquing is a mechanical method to ensure that the electrical path resistances is very low. But it does not truly indicate the quality of the electrical path resistance. The only true method is to measure each intercell connection resistance.

Megger has several DLROs and MOMs that are appropriate for intercell connection resistance. The portability of the instruments allows effortless mobility around battery strings.

The instruments are built into strong, lightweight cases that are equally at home in the field or in the laboratory. They are light and small enough to be taken into areas which were previously too small to gain access.

DLRO® 247000 series

- Resolution to $0.1\mu\Omega$ on $599.9\mu\Omega$ range
- Standard inaccuracy of $\pm 0.25\%$
- Large, digital LED readout

The 247000 Series of DLROs are a family of highly accurate instruments that provide a simple, practical and reliable means of making low-resistance tests in the field. They also are ideal for production quality control. They operate on the four-wire measurement principle, thus eliminating lead and contact resistances. With basic accuracies of $\pm 0.25\%$ and resolution down to $0.1\mu\Omega$, they are nonetheless designed to be rugged and portable for use at the job site. A variety of optional test leads and calibration resistance standards are offered for use with them.



DLRO247001

DLRO10 and DLRO10X

- Accurate results in under three seconds
- Fuse protected to 600 V
- Automatically detects continuity in potential and current connections
- Alpha-numeric keypad for entering test notes (DLRO10X)
- User configurable high and low limits (DLRO10X)
- Printer output and memory (DLRO10X)

The DLRO10 and DLRO10X are fully automatic instruments, selecting the most suitable test current, up to 10 A DC to measure resistance from $0.1\mu\Omega$ to 2000Ω on one of seven ranges.

For users who desire more control over the measurement process, DLRO10X uses a menu system to allow manual selection of the test current. DLRO10X also adds real-time download of results and on-board storage for later download to a PC.



DLRO10X

MJÖLNER 200 and MJÖLNER 600

- True DC ripple free current
- Inaccuracy $\pm 0.3 \mu\Omega$
- Two displays LED and LCD for visibility in all conditions
- Low weight, 8.8 kg (19.4 lbs) and 13.8 kg (30.4 lbs)
- Fully automatic testing

MJÖLNER is designed to measure the resistance of circuit breaker contacts, bus-bar joints, contact elements in bus-bars and other high-current links. The product has been designed with safety, ease of use and versatility in mind. There are two models, one 200 A output current and one 600 A.

With MJÖLNER it is possible to make measurements according to the DualGround™ method. This means that the test object will be grounded on both sides throughout the test giving a safer, faster and easier workflow.



MJÖLNER 200

MOM200A and MOM600A

- Resolution $1 \mu\Omega$ on 1999 $\mu\Omega$ range
- Standard inaccuracy of $\pm 1\%$

MOM200A/600A are ideal for finding poor connections since they can put out 100 A for extended periods. Its range extending up to 20 milliohms makes it ideal for measuring many different types of connections.

MOM690

- Resolution $1 \mu\Omega$ on 200 m Ω range
- Standard inaccuracy of $\pm 1\%$
- MOMWin™ software
- AC output

In addition to high current capacity, MOM690™ features microprocessor-based measurement, storage and reporting. The built-in software enables you to carry out an individual test or an entire series of tests and store the results.

With the optional MOMWin™ software you can also export the test results to a PC for further analysis and reporting. Ranges are set automatically, resistances are measured continually and test results can be automatically captured at a preset test current.



MOM600A



MOM690

Multimeters

MMC850 Multi-conductor AC Digital Clampmeter

- Single or multiple conductor measurement
- Flat or round section cables
- Backlit display
- Cable centralizing clamp

The MMC850 offers a unique solution to current measurement in multiconductor cables without the need to split cables. The MMC850 is simply clamped to a multi-conductor cable and the current flowing is then read.

Multimeters

Megger multimeters compliment the solution to measuring and maintaining battery strings and cells. All instruments undergo rigorous testing throughout their design and manufacture and are suitable for use in field service applications. All are CE marked and designed to National and International Safety Standard, EN61010-1. They include such features as large digital displays, automatic power down, water and dust resistance. There are three series of Megger multimeters, the M8000, M7000 and AVO300 depending upon needs and features wanted.



MMC850



M8037

Insulation Resistance Test Equipment

Batteries are supposed to be well insulated from adjacent equipment and metallic objects. The insulation provides several benefits: 1) keeps the charge in the battery rather than letting it leak, 2) provides for normal float current, and 3) reduces energy losses. If a battery is leaking electrolyte, then there may be a path to ground. When a path exists, the current needed to keep the battery fully charged increases. It also shortens the length of back-up time of the battery depending upon the severity of the leak. An insulation resistance test can identify whether there are leaks. The insulation resistance is measured across one of the terminals of the battery to some ground, presumably the battery rack or tray. It is a very easy test to perform and provides for a lot of confidence in the overall state of electrical insulation.

This test applies a DC voltage, say 500 Vdc, between the buss, off-line and the rack. Then measures the DC leakage current to calculate resistance in MΩ or GΩ. The higher the resistance is the better. This test is recommended at installation and whenever a leak may be suspected (from tell-tale signs such as salt build-up.)

Megger offers the MIT400 Series insulation and continuity testers designed for electrical testing by power utilities, industrials, telecommunication companies, commercial/ domestic electricians and anyone with unique test voltage requirements. The wide range of features also makes the MIT400 Series ideal for maintenance technicians and engineers.

These instruments are available from as low as 50 V to as high as 1 kV. For analytical applications, multiple test voltages are desired.

MIT400 series insulation resistance testers

- Choice of 4 models for commercial and plant applications: MIT Models 400, 410, 420 and 430
- Choice of 3 models for telecom applications: MIT Models 480, 481 and 485
- “Special Applications” model for those who need a unique test voltage, MIT Model 40X offers a variable insulation test voltage from 10 V to 100 V applications in 1 V steps—providing a solution to practically any unusual measurement requirement you may have.

The series consists of eight instruments

MIT400	250 V, 500 V and 1000 V
MIT410	50 V, 100 V, 250 V, 500 V and 1000 V plus PI and DAR
MIT420	Same as Model 410 plus result storage and download
MIT430	Same as Model 420 plus Bluetooth® download

MIT480	50 V, 100 V
MIT481	50 V, 100 V, 250 V, 500 V, 1000 V plus PI, DAR and result storage
MIT485	Same as Model 481, plus Bluetooth® download
MIT40X	10 V to 100 V in 1 V steps



MIT410

Your "One Stop" Source for all your electrical test equipment needs

- Battery Test Equipment
- Cable Fault Locating Equipment
- Circuit Breaker Test Equipment
- Data Communications Test Equipment
- Fiber Optic Test Equipment
- Ground Resistance Test Equipment
- Insulation Power Factor (C&DF) Test Equipment
- Insulation Resistance Test Equipment
- Line Testing Equipment
- Low Resistance Ohmmeters
- Motor & Phase Rotation Test Equipment
- Multimeters
- Oil Test Equipment
- Portable Appliance & Tool Testers
- Power Quality Instruments
- Recloser Test Equipment
- Relay Test Equipment
- T1 Network Test Equipment
- Tachometers & Speed Measuring Instruments
- TDR Test Equipment
- Transformer Test Equipment
- Transmission Impairment Test Equipment
- Watthour Meter Test Equipment
- TATES® Terminal Blocks & Test Switches
- Professional Hands-On Technical and
- Safety Training Programs

Megger is a world leading manufacturer and supplier of test and measurement instruments used within the electric power, building wiring and telecommunication industries.

With research, engineering and manufacturing facilities in the USA, UK and Sweden, combined with sales and technical support in most countries, Megger is uniquely placed to meet the needs of its customers worldwide.

For more information about Megger and its diversified line of test and measurement instruments:
www.megger.com

Megger is certified according to ISO 9001 and 14001.

Megger is a registered trademark

Technical Sales Offices

Dallas USA
Norristown USA
Toronto CANADA
Dover UK
Trappes FRANCE
Oberursel GERMANY
Täby SWEDEN
Johannesburg SOUTH AFRICA
Kingdom of BAHRAIN
Mumbai INDIA
Chonburi THAILAND
Sydney AUSTRALIA

Megger ^R
WWW.MEGGER.COM